



THIS INSTALLATION MANUAL CONTAINS
INFORMATION ON THE FOLLOWING
SXD SERIES AMPLIFIERS.

SXD 1000.1

SXD 2000.1

SXD 1100.2

SXD 1600.4

AVIONIXX™ IS A TRADEMARK OF DYNAMIC AUDIO

Company Message

Congratulations on the purchase of your new **SXD Series** amplifier. Our engineers designed your amplifier with performance in mind, with numerous built-in features, making it user-friendly and flexible for any elaborate system you can imagine. In addition, the highest grade materials were used in manufacturing your amplifier to provide premium audio quality and efficiency, ensuring you, our valued customer, the highest quality and performance that you demand deserve, without compromise.

Product Description

Your **SXD Series** amplifier are compatible with most factory and after-market installed audio systems. This device is high power audio amplifier. Use it responsibly. This amplifier is designed for installation in vehicles with a 12V negative ground electrical system. Attempting to connect or operate the amplifier in another type of electrical system may cause damage to the amplifier or the electrical system. For optimal performance, we highly recommend that you have your **SXD Series** amplifier installed by a qualified specialist. The quality of the installation greatly affects the performance and reliability of your equipment and sound system and your warranty coverage.

PRACTICE SAFE SOUND

PROLONGED EXPOSURE TO SOUND PRESSURE LEVELS OVER 100dB MAY CAUSE PERMANENT HEARING LOSS. HIGH POWERED AUTOSOUND SYSTEMS MAY PRODUCE SOUND PRESSURE LEVELS WELL OVER 100dB. USE COMMON SENSE AND PRACTICE SAFE LISTENING.

To establish a safe level, start with your volume control at a low setting. Slowly increase the volume until you can hear the music clearly without any distortion. Once you have established a comfortable volume, try not to increase it beyond that for prolonged periods of time.

Sound Pressure Example :

30dB Library, soft whispers	90dB Subway, motorcycle, lawn mower
50dB Light traffic, normal conversation	100dB Chain saw
70dB Vacuum cleaner, hair dryer	120dB Live concert
80dB Average city traffic, garbage disposals	140dB Jet plane, gunshot

Read the instructions - Read all of the operating instructions and understand all of the safety precautions before installing and operating the amplifier. If you feel you do not have the knowledge, tools, and skills, we recommend that you have your **SXD Series** amplifier installed by a specialist. The quality of the installation will affect the performance and reliability of your equipment and system.

Follow the instructions - The instructions are intended to help you safely obtain the best performance from the amplifier. Carefully follow all installation and operating instructions.

Save the operating manual - Keep the manual in a safe place after installing the amplifier you may have questions later.

Warranty Information

Please return the enclosed warranty registration card and retain your original purchase receipt and carton should you require warranty service.

This product is guaranteed against defects in material and workmanship for a period of two(2) years from the date of purchase or delivery to the original purchaser. During this period, Dynamic Audio (DA) will replace or repair, at its discretion, without charge for parts or labor, any product that exhibits such manufacturing defect. DA assumes no liability for incidental or consequent damages or expenses related to the use or failure of this product. This warranty does not apply to any product which has been abused or operated in or under conditions exceeding the manufacturer's claim of serviceability. This is the sole warranty, no other warranty is expressed or implicated.

For warranty service, contact the manufacturer at the address or phone number on the back of the manual for a return authorization. Upon receipt of authorization, return the unit, freight prepaid, including a copy of the original purchase receipt clearly showing the date of purchase.

Serial Number: _____

Model Number: _____

Installation and Use

Installation-Mounting the Amplifier

Step1 - Disconnect the positive(+) battery cable before mounting the amplifier or making any connections. Check the battery and alternator ground(-) connections. Make sure they are properly connected and free of corrosion.

Step2 - Choose a mounting location for your amplifier. Find a location on a flat surface away from heat and moisture. Be sure the mounting location and the drilling of pilot holes for mounting will not present a hazard to any wires, control cables, fuel lines, fuel tanks, hydraulic lines, or other vehicle systems or components. Common mounting locations are in the trunk area, or under the front passenger seat (min. 3 in. clearance). Choose a location with adequate air circulation. The amplifier will dissipate heat more efficiently if mounted vertically.

Step3 - Place the amplifier in the mounting location, and mark the position if the holes with a marker, pen or pencil. Carefully drill the mounting holes in the marked positions.

 Check for fuel lines, fuel tanks, hydraulic lines and other vehicle systems before drilling any pilot holes.

Step4 - Use the supplied mounting screw to securely fasten the amplifier to the mounting surface.

Best - Vertical Mounting

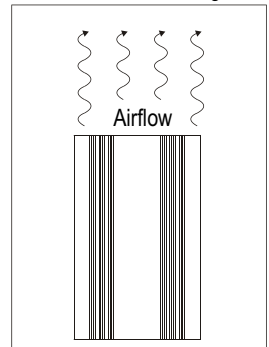

Good - Horizontal Mounting

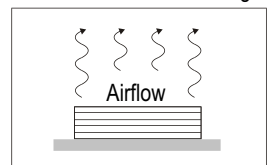

Never Mount Upside Down

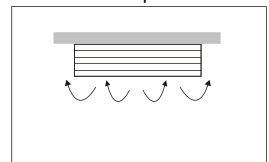

Installation - Power Connections

Step1- Run a power cable from the battery to the amplifier mounting location. Use rubber grommets to protect the cable anywhere it has to go through metal. Use the following size power and ground cable or larger for each **SXD Series** amplifier.

SXD 1600.4 - #4 AWG min.
SXD 1100.2 - #4 AWG min.

SXD 1000.1 - #8 AWG min.
SXD 2000.1 - #8AWG min.

Step2- Connect one end of a water resistant in-line fuse holder to the power cable. Connect the other end of the water resistant fuse holder to the positive battery post with 18" (or less) of the same cable. This fuse location will protect the system and the vehicle against the possibility of a short circuit in the power cable. Be sure to use a fuse and fuse holder adequate for the application. Do not place a fuse in the holder at this time. The maximum fuse rating for each **SXD Series** amplifier is:

SXD 1600.4 - 60 Amp
SXD 1100.2 - 30 Amp

SXD 1000.1 - 30 Amp
SXD 2000.1 - 60 Amp

Warning!

To protect the system and the vehicle against the possibility of a short circuit, be sure to use a fuse and fuse holder adequate for the application.

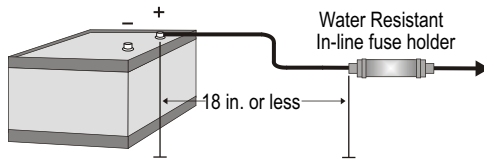

Step3 - Run a remote turn on cable from the switched +12V source you will be using to turn on the system components. This may be toggle switch, a relay, or your source unit's remote trigger wire, or power antenna trigger wire. Run this lead to the amplifier mounting location. Use #12 AWG wire or larger.

Step4 - Locate secure grounding connection as close to the amplifier as possible. Make sure the location is clean and free of paint and debris so it provides a direct electrical connection to the frame of the vehicle. Connect one end of a short piece of the same size cable as the power cable to the grounding point. Run the other end of the cable to the amplifier mounting location.

Step5 - Connect the ground cable to the screw terminal labeled "GND"

Step6 - Connect the power cable to the amplifier at the screw terminal labeled "+12V"

Step7 - Connect the remote turn on cable to the screw terminal labeled "REM"

Installation- Speaker Connection

Step1 - Run #10 AWG or larger connecting wire from your speaker to the amplifier mounting location. Use grommets anywhere, the wires have to pass through holes in the metal frame or sheet metal. Connect to the speakers according to the type of terminals on each speaker.



Keep amplifier input cables as far away from power cable and speaker cables as possible to prevent engine noise, which sounds like a high-pitched whine, from entering the system.

Step2 - Strip 3/8" of insulation from the end of each wire and twist the wire strands together tightly. Make sure there are no stray strands that might touch other wires or terminals and cause a short circuit.

Step3 - Tin the ends with solder to eliminate stray strands and to provide a secure connection.

Step4 - Connect the wire ends to your amplifier as follow:



Speaker multiple speaker loads totaling less than 4 ohms are not recommended for "Bridged" or "2+1 mode" to the 4 channel or 2 channel output terminals of **SXD 1100.2 & SXD 1600.4**

SXD 1600.4 Speaker Terminals

4 Channel System

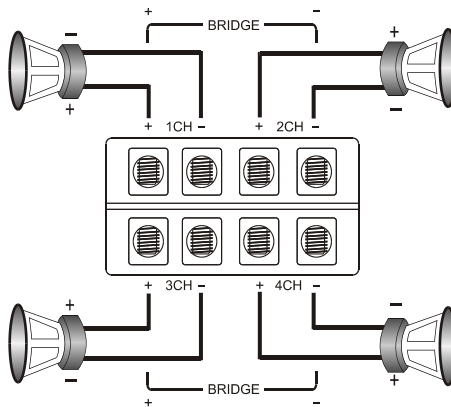

■ Minimum final loudspeaker impedance: 2Ω per channel.

3 Channel System

This application allow the **SXD** Series amplifier to function as a 3 channel amplifier by mono bridging the rear right and left channels, while leaving the front channels in stereo or vice versa.

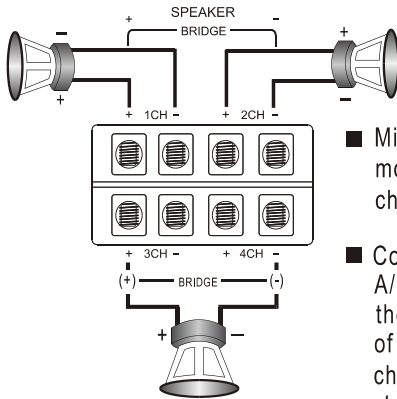

- Minimum final loudspeaker impedance : 4Ω for the mono bridged channels and 2Ω per each stereo channel.
- Connctet the (1+) and (2-) terminals to bridge the A/B channels, or the (3+) and (4-) terminals to bridge the C/D channels, making sure they match the polarity of the speaker connections. Follow the remaining channel and polarity markings for the stereo channels, making sure they match the channel and polarity of the speaker connections

2 Channel Bridged System

This application allows the **SXD** Series 4 channel amplifier to function as a 2 channel amplifier by mono bridging the front right & left channels and the rear right & left channels.

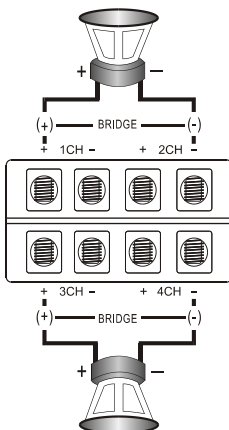

- Minimum final loudspeaker impedance: 4Ω per channel.
- Connect the (1+) and (2-) terminals to bridge the 1/2 channels and the (3+) and (4-) terminals to bridge the 3/4 channels, making sure they match the polarity of the speaker connections.

SXD 1100.2 Speaker Terminals

2 Channel Operation

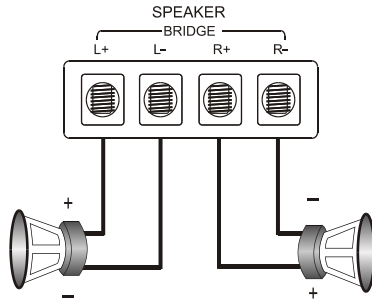

- Minimum final loudspeaker impedance: 2Ω per channel.
- Follow (L+) (L-) and (R+) (R-) channel and polarity markings, making sure they match the channel and polarity of the speaker connections.

Bridged Mono

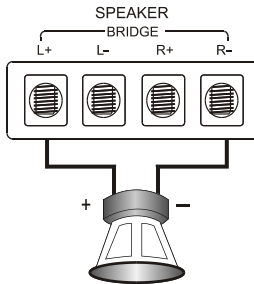

- Minimum final loudspeaker impedance: 4Ω .
- Connect to the left(L+) and right (R-) amplifier terminals, making sure they match the polarity of the speaker connections.

SXD 1000.1 & SXD 2000.1 Amplifier Speaker Terminals

Mono Channel Operation

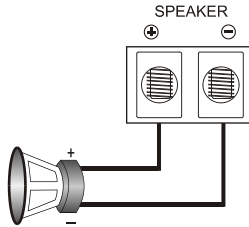

- Minimum final loudspeaker impedance: $2\Omega \times 2 / 1\Omega \times 1$
- Connect the left and right amplifier terminals, making sure they match the polarity of the speaker connections.

Installations - RCA Jack Connections

Low level, high impedance, gold plated RCA jacks are provided for preamp level inputs. Use heavy duty RCA cables designed for mobile applications.

- Step1 - Run the RCA cables carefully, maintaining as much as possible from power, speaker, and accessory wiring.
- Step2 - Connect the RCA plugs as follows. Make sure the RCA plugs fit tightly for a secure connection.

SXD Series Input Connects

RCA Input Jack

Single Amplified System

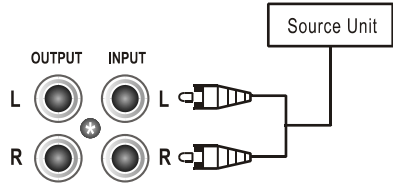

Bi-Amplified System

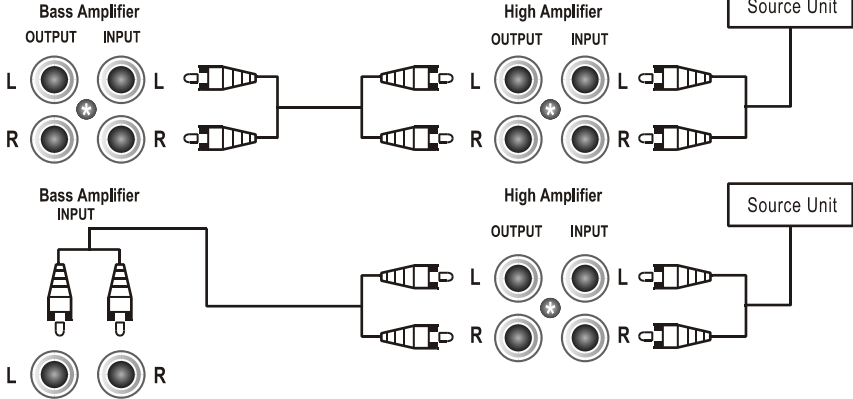

Installation - Check All Connections

Recheck all connections before reconnecting the positive(+) battery cable. Insert the correct fuse in the fuse holder near the battery before attempting to return on the system.

Operation

Operations-Input Level Adjustments

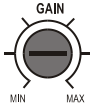

Adjust the input level for the marked channel(s) with a small screwdriver through the opening marked "GAIN". Turn clockwise to increase the level, counterclockwise to decrease. Amplifiers will run cooler and produce less system noise at lower level settings.

Consult and experienced installation specialist for assistance in balancing the levels in multi amplifier systems, or systems with signal processing accessories.

Operation-Built-in Crossovers

SXD1600.4, SXD1100.2 - CROSSOVER SELECTION

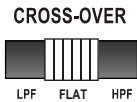

The SXD series amplifier have built-in low-pass and high-pass crossovers for bi-amplifying your system. Select "FLAT or LPF or HPF" by moving the position of the slide switch for each pair of channels. Selecting "FLAT" defeats the crossover functions.

SXD1600.4, SXD1100.2, SXD1000.1, SXD2000.1 - FREQUENCY ADJUSTMENT

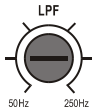

After selecting the crossover functions, adjust the low pass or high pass frequency with a small screwdriver through the opening marked "LPF" or "HPF". Turn clockwise to set to a higher frequency, counterclockwise to set to a lower frequency.

Operation- Protection Circuits and LED Indicators

"POWER" LED INDICATOR- Provides a visual indication that the amplifier is turned on and functioning under normal operation.

"PROTECT" LED INDICATOR-Provides a visual indication that a problem exists and the protection circuitry has shut down the amplifier. Turn the system off and correct the problem before turning the system back on.

THERMAL PROTECTION- Indicated by the "Protect" LED, the amplifier will shut down if its temperature exceeds a safe operating level. The amplifier will remain off until it cools to safe operating temperature. Exercise care, the exterior if the amplifier will get uncomfortably hot to the touch before shutting down.

OVERLOAD AND SHORT CIRCUIT PROTECTION- Indicated by both the "POWER" and "PROTECT" LEDs, the amplifier will shut down if a short circuit condition exists, or if electrical current demands exceed safe levels.

Operation- Amplifier Accessory

Remote Control Module available for SXD1000.1, SXD2000.1



SXD 1000.1, SXD 2000.1
Gain Control - 6V to 0.2V

OPERATION- Location of Terminals Controls and LED Indicators

SXD 1600.4 4 Channel Amplifier

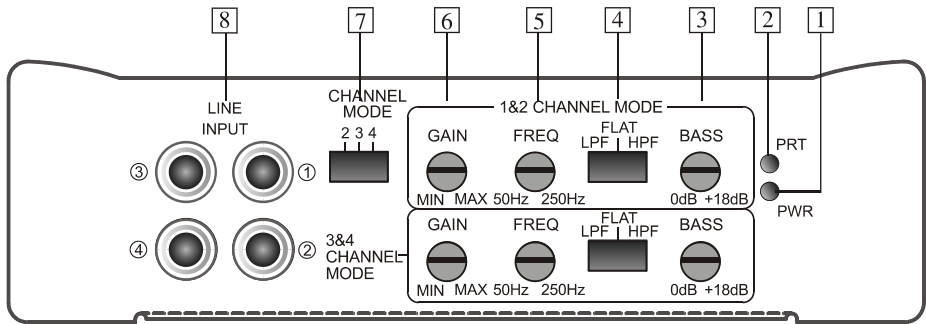

- | | | |
|------------------------|----------------------|------------------------|
| 1. Power LED | 2. Protect LED | 3. Bass Control |
| 4. Crossover Switch | 5. Frequency Control | 6. Input Level control |
| 7. Channel Mode Switch | 8. RCA Input Jacks | |

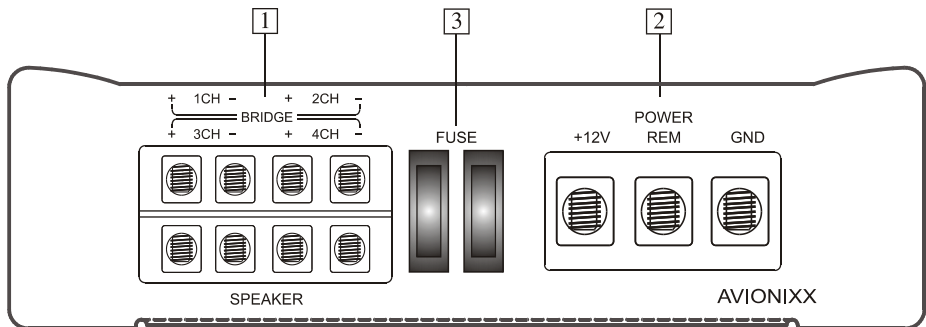

- | | | |
|----------------------|--------------------|----------|
| 1. Speaker Terminals | 2. Power Terminals | 3. Fuses |
|----------------------|--------------------|----------|

OPERATION- Location of Terminals Controls and LED Indicators

SXD 1100.2 2 Channel Amplifier

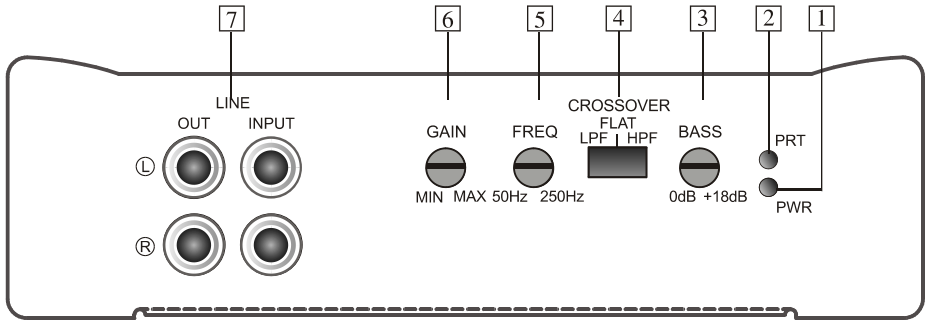

- | | | |
|----------------------------|----------------------|------------------------|
| 1. Power LED | 2. Protect LED | 3. Bass Control |
| 4. Crossover Switch | 5. Frequency Control | 6. Input Level control |
| 7. RCA Input /Output Jacks | | |

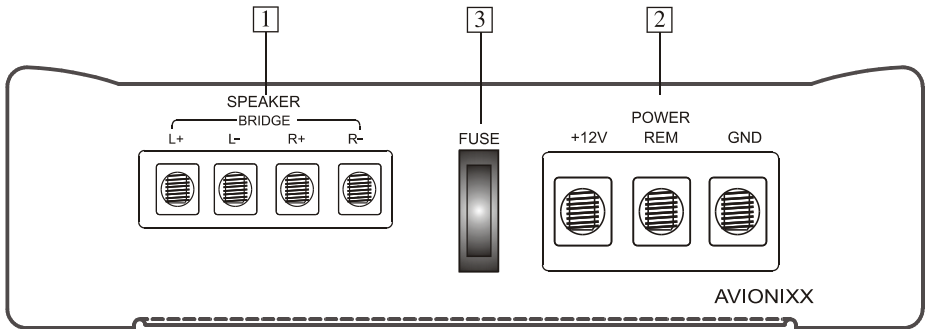

- | | | |
|----------------------|--------------------|----------|
| 1. Speaker Terminals | 2. Power Terminals | 3. Fuses |
|----------------------|--------------------|----------|

OPERATION- Location of Terminals Controls and LED Indicators

SXD 1000.1, SXD2000.1 Mono Channel

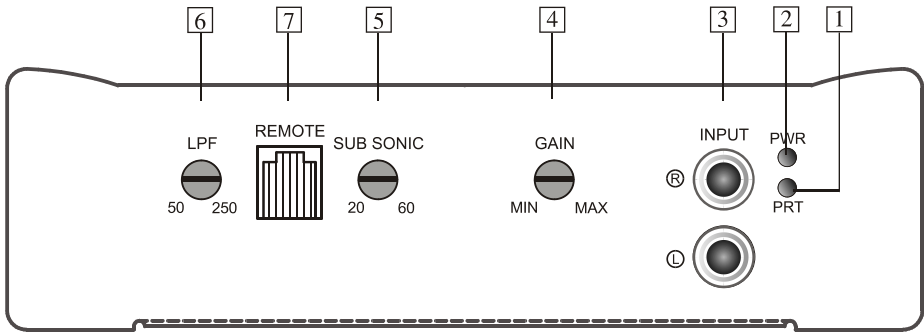

- 1. Protect LED
- 2. Power LED
- 3. RCA Jacks
- 4. Input Level control
- 5. Subsonic Control
- 6. Frequency Control (LPF)
- 7. Remote Gain Control Jack

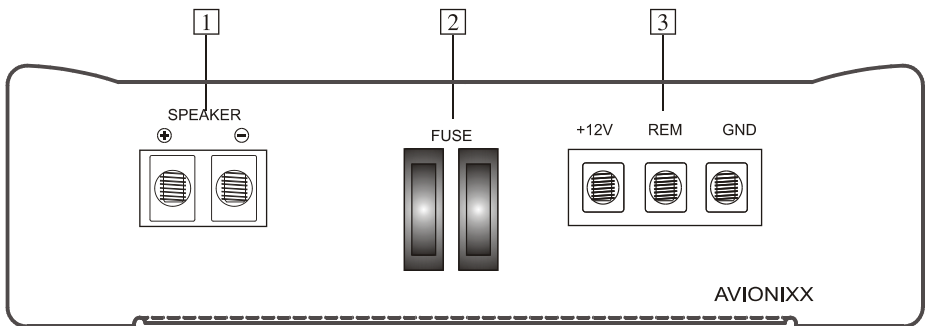

- 1. Speaker Terminals
- 2. Fuses
- 3. Power Terminals

Trouble Shooting

Problem	Probable Cause	Possible Solution
Amplifier does not turn on (Power light is off)	Low or no remote turn on voltage, or no remote turn on connection. Blown Fuse Wiring Problems Blown Speakers	Check the remote turn on connection and the voltage at the amplifier and source unit Contact the manufacturer Recheck all connections Check speakers on another source
Amplifier shut down (Protect light is on) (Both Power & Protect light on)	Thermal protection mode against overheating Overload or speaker short protection mode	Check for adequate ventilation Check load impedance (2 ohm stereo, 4 ohm bridged) Check speaker wiring for short to the vehicle chassis
Speaker Output Low or Distorted	Input level not properly adjusted Speaker damage	Reduce input level Check speakers on an other source
Poor Bass Response	Speakers out of phase	Recheck speaker wiring Reverse polarity of one channel
Ticking Noise	Radiated noise from spark plug wires	Reroute amplifier input wiring
Whining Noise	Alternator noise caused by poor grounding of amplifier, source, other component, battery, or alternator	Move input cables as far away from power and speaker cable as possible Check all ground connections Install a noise filter Install a noise filter on the source unit's power cable Install a coupling transformer in the signal path to improve ground isolation for the signal path

Specifications

	SXD 1000.1	SXD 2000.1	SXD 1100.2	SXD 1600.4
Maximum power@ 1.Ω	1 x 800W	1 x 1500W	N/A	N/A
Maximum power@ 4 Ω bridged	N/A	N/A	1 X 850W	2 X 700W
RMS power @ 4.Ω bridged	N/A	N/A	300 W	2 x 240 W
RMS POWER@ 1.Ω	1 x 280W	1 x 580W	N/A	N/A
RMS power @ 2.Ω THD < 0.5%	1 x 200 W	1 x 450 W	2 x 150 W	4 x 120 W
Signal to Noise Ratio	>- 90 dB	>- 90 dB	>- 95 dB	>- 95 dB
Damping Factor	>200	>200	>250	>250
Frequency Response	20Hz-250Hz	20Hz-250Hz	15Hz-30KHz	15Hz-30KHz
Stereo Separation	-	-	>- 60 dB	>- 60 dB
Input Sensitivity	200mV-6V	200mV-6V	200mV-6V	200mV-6V
Input Impedance	30K.Ω	30K.Ω	10K.Ω	10K.Ω
High Pass Frequency	N/A	N/A	40-240Hz	40-250Hz
Low Pass Frequency	50-250Hz	50-250Hz	40-240Hz	40-250Hz
Dynamic Bass Boost	N/A	N/A	18dB	18dB
Remote Control Capability	Yes (optional)	Yes (optional)	N/A	N/A

In pursuit of constantly improving our products, the information in this document is subject to change without prior notice. We make no warranty of any kind regarding the material, assume no responsibility for errors, misprints, or omissions, and assume no liability for damages resulting from the use of this information here in contained.

**DYNAMIC AUDIO
7110 MOTZ STREET
PARAMOUNT, CA 90723**

PH: (562) 630-8755

FX: (562) 630-8750

WWW.AVIONIXX.COM